



# EA-410

## Earth Auger

SINCE 1979  
**precisionusa.com**  
YOUR GOLF COURSE SUPERMARKET  
800-345-1960

# *Operator's Manual*

### ⚠ WARNING



#### **Burn Hazard**

*The muffler or catalytic muffler and surrounding cover may become extremely hot. Always keep clear of exhaust and muffler area, otherwise serious personal injury may occur.*

### ⚠ WARNING

*The engine exhaust from this product contains chemicals known to the State of California to cause cancer, birth defects or other reproductive harm.*

### ⚠ WARNING



*Users of this equipment risk injury to themselves and others if the unit is used improperly and/or safety precautions are not followed. ECHO provides an operator's manual. It must be read and understood for proper and safe operation. Failure to do so could result in serious injury.*

Specifications, descriptions and illustrative material in this literature are as accurate as known at the time of publication, but are subject to change without notice. Illustrations may include optional equipment and accessories, and may not include all standard equipment.

TABLE OF CONTENTS

Table of Contents ..... 2

Introduction ..... 3

    The Operator’s Manual ..... 3

Servicing Information ..... 3

    Parts/Serial Number..... 3

    Service ..... 3

    Echo Consumer Product Support ..... 3

    Product Registration ..... 3

    Additional or Replacement Manuals ..... 3

Safety..... 4

    Manual Safety Symbols and Important Information ..... 4

    International Symbols ..... 5

    Personal Condition and Safety Equipment ..... 6

    Equipment..... 9

Emission Control (Exhaust & Evaporative)..... 10

    EPA 2010 and Later and/or C.A.R.B. TIER III ..... 10

Description ..... 11

Contents ..... 13

Assembly ..... 14

    Throttle Handle Assembly..... 14

    Auger Installation ..... 14

    Auger Extension..... 15

Operation ..... 16

    Fuel ..... 16

    Starting Cold Engine ..... 18

    Starting Warm Engine..... 18

    Stopping Engine..... 19

    Drilling ..... 20

Maintenance ..... 21

    Skill Levels ..... 21

    Maintenance Intervals..... 21

    Air Filter..... 22

    Fuel Filter ..... 22

    Spark Plug ..... 23

    Cooling System..... 23

    Exhaust System..... 24

    Gear Housing..... 25

    Carburetor Adjustment..... 25

Troubleshooting ..... 27

Storage ..... 28

    Long Term Storage (Over 30 Days)..... 28

Specifications..... 29

Auger Accessoires..... 30

Warranty Statements ..... 31

Product Registration ..... 33

Notes ..... 34

## INTRODUCTION

Welcome to the ECHO family. This ECHO product was designed and manufactured to provide long life and on-the-job dependability. Read and understand this manual. You will find it easy to use and full of helpful operating tips and SAFETY messages.

### The Operator's Manual

Keep it in a safe place for future reference. Contains specifications and information for safety, operation, maintenance, storage and assembly specific to this product.

## SERVICING INFORMATION

### Parts/Serial Number

Genuine ECHO Parts and ECHO REPOWER™ Parts and Assemblies for your ECHO products are available only from an Authorized ECHO Dealer. When you do need to buy parts **always** have the Model Number and Serial Number of the unit with you. You can find these numbers on the engine housing. For future reference, write them in the space provided below.

Model No. \_\_\_\_\_ SN. \_\_\_\_\_



### Service

Service of this product during the warranty period must be performed by an Authorized ECHO Service Dealer. For the name and address of the Authorized ECHO Service Dealer nearest you, ask your retailer or call: 1-800-432-ECHO (3246). Dealer information is also available on our Web Site. When presenting your unit for Warranty service/repairs, proof of purchase is required.

### Echo Consumer Product Support

If you require assistance or have questions concerning the application, operation or maintenance of this product you may call the ECHO Consumer Product Support Department at 1-800-673-1558 from 8:00 am to 5:00 pm (Central Standard Time) Monday through Friday. Before calling, please know the model and serial number of your unit.

### Product Registration

To ensure trouble free warranty coverage it is important that you register your ECHO equipment on-line at [www.echo-usa.com](http://www.echo-usa.com) or by filling out the product registration sheet included in this manual. Registering your product confirms your warranty coverage and provides a direct link between you and ECHO if we find it necessary to contact you.

### Additional or Replacement Manuals

**Replacement Operator, Safety Manuals, and Parts Catalogs** are available from your ECHO dealer or at [www.echo-usa.com](http://www.echo-usa.com) or by contacting ECHO Inc., 400 Oakwood Road, Lake Zurich, IL 60047 (800-673-1558). Always check the ECHO Web Site for updated information.



For more information scan this QR code.

**Safety Videos** are available from your Echo dealer. A \$5.00 shipping charge will be required for each video.

---

**SAFETY**

---

**Manual Safety Symbols and Important Information**

Throughout this manual and on the product itself, you will find safety alerts and helpful, informational messages preceded by symbols or key words. The following is an explanation of those symbols and key words and what they mean to you.

** DANGER**

*The safety alert symbol accompanied by the word “DANGER” calls attention to an act or condition which WILL lead to serious personal injury or death if not avoided.*

** WARNING**

*The safety alert symbol accompanied by the word “WARNING” calls attention to an act or condition which CAN lead to serious personal injury or death if not avoided.*

** CAUTION**

*The safety alert symbol accompanied by the word “CAUTION” calls attention to an act or condition which may lead to minor or moderate personal injury if not avoided.*

**NOTICE**













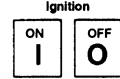



*The enclosed message provides information necessary for the protection of the unit.*

Note: This enclosed message provides tips for use, care and maintenance of the unit.

**CIRCLE AND SLASH SYMBOL**

This symbol means the specific action shown is prohibited. Ignoring these prohibitions can result in serious or fatal injury.

**International Symbols**

Symbol	Description	Symbol	Description	Symbol	Description	Symbol	Description
	Warning, See Operator's Manual	<b>H</b>	Carburetor Adjustment - High speed mixture		DO NOT allow flames or sparks near fuel		Ignition ON / OFF
	Wear eye, ear and head protection	<b>T</b>	Carburetor Adjustment - Idle speed		DO NOT smoke near fuel		Primer Bulb
	Wear hand and foot protection	<b>L</b>	Carburetor Adjustment - Low speed mixture		Choke Control "Run" Position (Choke Open)		Choke Control "Cold Start" Position (Choke Closed)
	Safety/Alert		Emergency Stop		Keep feet and legs away from blade		Maintain Firm Grip With Both Hands On Auger During Operation
	Hot Surface		Fuel and oil mixture		Never Operate Auger In an Area With Underground Electric, Gas, Water, Or Telephone Lines		



**LOOK BEFORE YOU PUMP!**  
Ethanol Percentage

0% - 10%	15% - 30% - 50% - 85%
----------	-----------------------

**USE E10 OR LESS FUEL**

Do not use any fuel containing greater than 10 percent ethanol (E10) in this equipment. It may cause damage or failure and is prohibited by Federal Law.  
For Details, see the "Fuel" Section of your Operators Manual

## Personal Condition and Safety Equipment

### WARNING

*Users of this product risk injury to themselves and others if the unit is used improperly and/or safety precautions are not followed. Proper clothing and safety gear must be worn when operating unit.*

#### Physical Condition

Your judgment and physical dexterity may not be good:

- If you are tired or sick.
- If you are taking medication.
- If you have taken alcohol or drugs.

Operate unit only if you are physically and mentally well.

#### Eye Protection

### WARNING

- **Eye protection that meets ANSI Z87.1 or CE requirements must be worn whenever you operate the unit.**
- **For additional safety, a full-face shield may be worn over safety glasses or goggles to provide protection from sharp branches or flying debris.**

#### Hand Protection

Wear sturdy, no-slip, rubber work gloves to improve your grip on the handles. Gloves also provide protection against cuts and scratches, cold environments, and reduce the transmission of machine vibration to your hands.

#### Hearing/Ear Protection

ECHO recommends wearing hearing protection whenever unit is used.

#### Breathing Protection

Operators who are sensitive to dust or other common airborne allergens may need to wear a dust mask to prevent inhaling these materials while operating unit. Dust masks can provide protection against dust, plant debris, and other plant matter such as pollen. Make sure the mask does not impair your vision, and replace the mask as needed to prevent air restrictions.

#### Proper Clothing

Wear snug-fitting, durable clothing:

- Pants should have long legs, shirts should have long sleeves.
- DO NOT WEAR SHORTS.
- DO NOT WEAR TIES, SCARVES, JEWELRY, or clothing with loose or hanging items that could become entangled in moving parts or surrounding growth.
- Keep clothing buttoned or zipped, and keep shirt tails tucked in.

Wear sturdy work shoes with nonskid rubber soles:

- DO NOT WEAR OPEN TOED SHOES.

- DO NOT OPERATE UNIT BAREFOOTED.

Keep long hair away from engine and air intake. Retain hair with cap or net.

Heavy protective clothing can increase operator fatigue, which may lead to heat stroke. Schedule heavy work for early morning or late afternoon hours when temperatures are cooler.

### **⚠ WARNING**

***The components of this machine generate an electromagnetic field during operation, which may interfere with some pacemakers. To reduce the risk of serious or fatal injury, persons with pacemakers should consult with their physician and the pacemaker manufacturer before operating this machine. In the absence of such information, ECHO does not recommend the use of ECHO products by anyone who has a pacemaker.***

### **Extended Operation / Extreme Conditions**

### **⚠ CAUTION**

***Prolonged exposure to cold and/or vibration may result in injury. Read and follow all safety and operation instructions to minimize risk of injury. Failure to follow instructions may result in painful wrist/hand/arm injuries.***

It is believed that a condition called Raynaud's Phenomenon, which affects the fingers of certain individuals, may be brought about by exposure to vibration and cold. Exposure to vibration and cold may cause tingling and burning sensations, followed by loss of color and numbness in the fingers. The following precautions are strongly recommended, because the minimum exposure, which might trigger the ailment, is unknown.

- Keep your body warm, especially the head, neck, feet, ankles, hands, and wrists.
- Maintain good blood circulation by performing vigorous arm exercises during frequent work breaks, and also by not smoking.
- Limit the hours of operation. Try to fill each day with jobs where operating the unit or other hand-held power equipment is not required.
- If you experience discomfort, redness, and swelling of the fingers followed by whitening and loss of feeling, consult your physician before further exposing yourself to cold and vibration.



### Repetitive Stress Injuries (RSI)

It is believed that overusing the muscles and tendons of the fingers, hands, arms, and shoulders may cause soreness, swelling, numbness, weakness, and extreme pain in those areas. Certain repetitive hand activities may put you at a high risk for developing a Repetitive Stress Injury (RSI). An extreme RSI condition is Carpal Tunnel Syndrome (CTS), which could occur when your wrist swells and squeezes a vital nerve that runs through the area. Some believe that prolonged exposure to vibration may contribute to CTS. CTS can cause severe pain for months or even years.

To reduce the risk of RSI/CTS, do the following:

- Avoid using your wrist in a bent, extended, or twisted position. Instead try to maintain a straight wrist position. Also, when grasping, use your whole hand, not just the thumb and index finger.
- Take periodic breaks to minimize repetition and rest your hands.
- Reduce the speed and force with which you do the repetitive movement.
- Do exercise to strengthen the hand and arm muscles.
- Immediately stop using all power equipment and consult a doctor if you feel tingling, numbness, or pain in the fingers, hands, wrists, or arms. The sooner RSI/CTS is diagnosed, the more likely permanent nerve and muscle damage can be prevented.

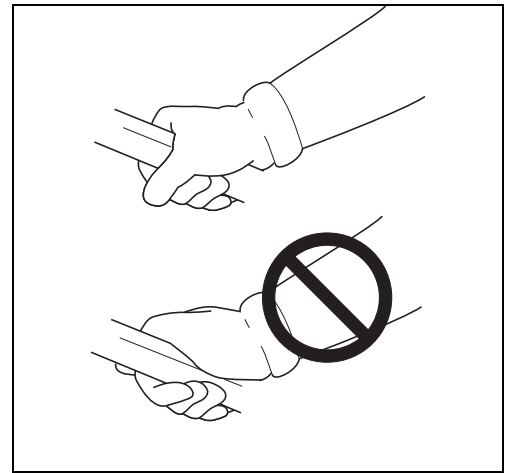

### **⚠ DANGER**

***All over head electrical conductors and communications wires can have electricity flow with high voltages. This unit is not insulated against electrical current. Never touch wires directly or indirectly, otherwise serious injury or death may result.***

### **⚠ DANGER**

***Do not operate this product indoors or in inadequately ventilated areas. Engine exhaust contains poisonous emissions and can cause serious injury or death.***

- Provide all users of this equipment with the Operator's Manual and Safety Manual for instructions on Safe Operation.
- Review area to be augered. Beware of underground hazards such as electrical lines, gas lines, water mains, or cable and telephone lines.
- Never use ice auger without checking with local authorities for safe ice thickness in lakes, ponds, and rivers.
- Spectators and fellow workers must be warned, and children and animals prevented from coming nearer than 3 m (10 ft.) while the unit is in use.
- Before starting the unit, equip yourself, and any person helping you, with the required Protective Equipment and Clothing. Do not wear loose or baggy clothing while operating the auger.
- Do not allow children to operate auger at any time.
- Always keep hands, arms, legs, and feet clear of the rotating auger.



- Do not carry the auger between holes with the engine running.
- Always shut engine off before making any repairs.
- Always hold throttle handle and support handle with thumbs and fingers tightly encircling the handles.
- Maintain footing and balance at all times. Do not stand on slippery, uneven or unstable surfaces. Do not work in odd positions or on ladders. Do not over reach. Do not operate auger in any position other than upright.
- Do not operate auger in any position other than upright.
- During operation, the muffler cover area will become very hot. Avoid contact during and immediately after operation. Allow engine and muffler to completely cool before performing any maintenance.



## Equipment

### ⚠ WARNING

**Use only ECHO attachments. Serious injury may result from the use of a non-approved attachment combination. ECHO, INC. will not be responsible for the failure of cutting devices, attachments or accessories which have not been tested and approved by ECHO. Read and comply with all safety instructions listed in this manual and safety manual.**

- Check unit for loose/missing nuts, bolts, and screws. Tighten and/or replace as needed.
- Check that the auger is firmly attached and in safe operating condition.
- Ice blades are very sharp. Wear gloves when handling or replacing.
- Do not use any attachment, accessory, or replacement part unless it is recommended in the Operator's Manual.
- Have repairs done only by an authorized ECHO Service Dealer.

### ⚠ WARNING

**Moving parts can amputate fingers or cause severe injuries. Keep hands, clothing and loose objects away from all openings.**

- ◆ ALWAYS stop engine, disconnect spark plug, and make sure all moving parts have come to a complete stop before removing obstructions, clearing debris, or servicing unit.
- ◆ DO NOT start or operate unit unless all guards and protective covers are properly assembled to unit.
- ◆ NEVER reach into any opening while the engine is running. Moving parts may not be visible through openings.

### ⚠ WARNING

**Check fuel system for leaks due to fuel tank damage, especially if the unit is dropped. If damage or leaks are found, do not use unit, otherwise serious personal injury or property damage may occur. Have unit repaired by an authorized servicing dealer before using.**

## EMISSION CONTROL (EXHAUST & EVAPORATIVE)

### EPA 2010 and Later and/or C.A.R.B. TIER III

The emission control system for the engine is EM (engine modification) and, if the second to last character of the Engine Family on the Emission Control Information label (sample below) is “C”, “K”, or “T”, the emission control system is EM and TWC (3-way catalyst). The fuel tank/fuel line emission control system is EVAP (evaporative emissions). Evaporative emissions for California models are only applicable to fuel tanks.

**An Emission Control Label** is located on the engine. (This is an EXAMPLE ONLY, information on label varies by engine FAMILY).

### Product Emission Durability (Emission Compliance Period)

The 50 or 300 hour emission compliance period is the time span selected by the manufacturer certifying the engine emissions output meets applicable emissions regulations, provided that approved maintenance procedures are followed as listed in the Maintenance Section of this manual.



DESCRIPTION

Locate the safety decal(s) on your unit. Make sure the decal(s) is legible and that you understand and follow the instructions on it. If a decal cannot be read, a new one can be ordered from your ECHO dealer. See PARTS ORDERING instructions for specific information.

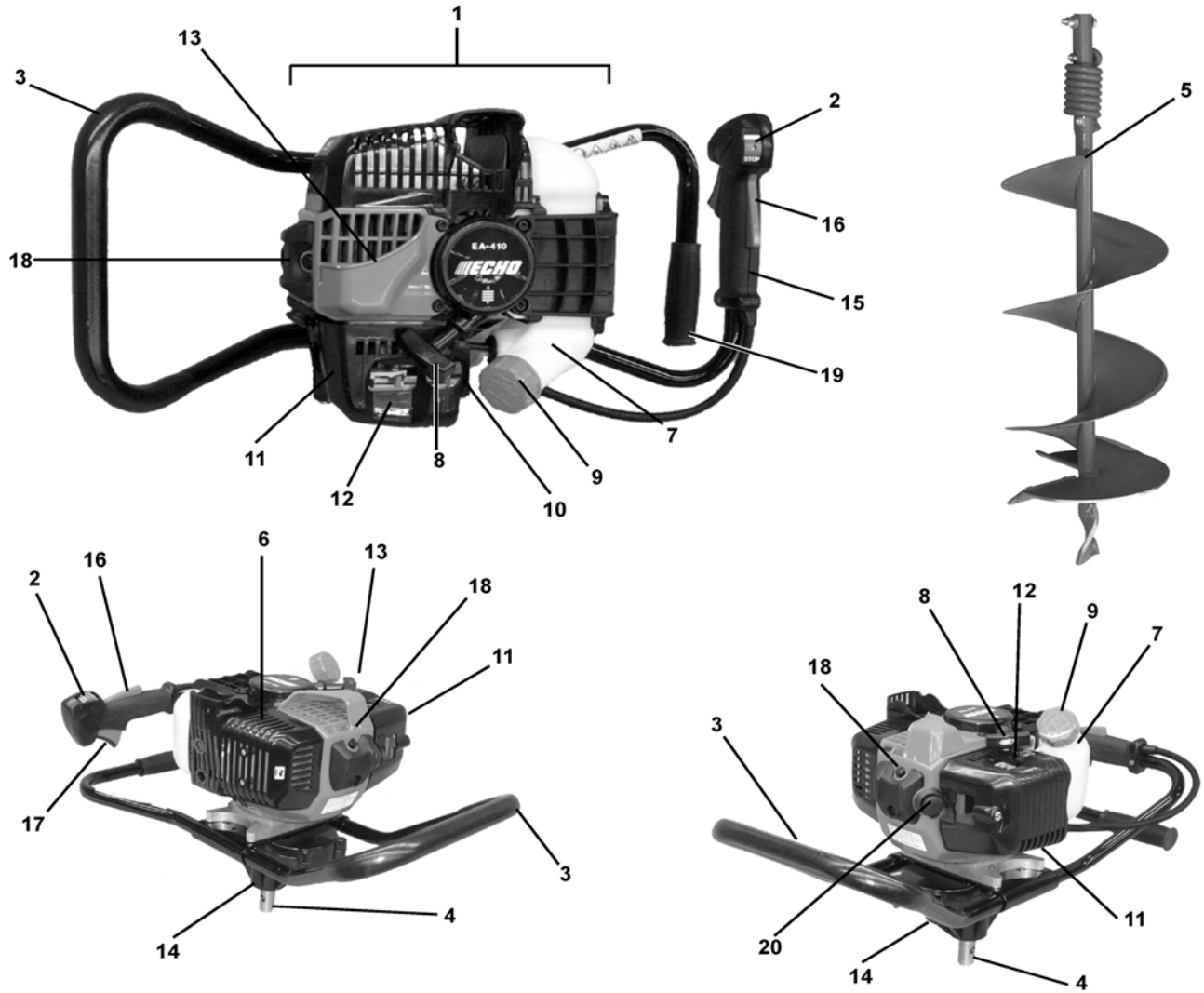



Handle Label



Hot Label



1. **POWER HEAD** - Includes the Engine, Clutch, Fuel System, Ignition System and Recoil Starter, and Auger Gear Case.
2. **STOP SWITCH** - "SLIDE SWITCH" mounted on top of the throttle handle. Move switch FORWARD to RUN, BACK to STOP.
3. **SUPPORT HANDLE** - Used for support grip by Operator during one-man operation.
4. **PTO SHAFT** - Power Take-Off Shaft provides power to Auger accessory.
5. **AUGER ASSEMBLY** - Connects to PTO Shaft. Auger Assembly is purchased separately as an accessory. See page 10 for list of auger accessories.
6. **SPARK ARRESTOR MUFFLER OR SPARK ARRESTOR MUFFLER WITH CATALYST** -The muffler or catalytic muffler controls exhaust noise and emission. The spark arrestor screen prevents hot, glowing particles of carbon from leaving the muffler. Keep exhaust area clear of flammable debris.
7. **FUEL TANK** - Contains fuel and fuel filter.
8. **RECOIL STARTER HANDLE** - Pull handle slowly until starter engages, then quickly and firmly. When engine starts, return handle slowly. DO NOT let handle snap back or damage to unit will occur.
9. **FUEL TANK CAP** - Covers and seals fuel tank opening.
10. **PURGE BULB** - Pumping purge bulb before starting engine draws fresh fuel from the fuel tank, purging air from the carburetor. Pump purge bulb until fuel is visible and flows freely in the clear fuel tank return line. Pump purge bulb an additional 4 or 5 times.
11. **AIR CLEANER** - Contains replaceable filter element.
12. **CHOKE** - The choke control is located at the rear of the air cleaner housing. Move choke lever to Cold Start (  ) to close choke for cold start. Move choke lever to "Run" (  ) position to open choke.
13. **AIR DEFLECTOR** - Deflects hot engine cooling air away from operator.
14. **GEAR CASE** - Sealed Gear Case provides 30.2 to 1 reduction for best combination of power and auger speed. Requires no user maintenance.
15. **THROTTLE HANDLE** - Contains main operator controls- Throttle Trigger, Stop Switch, and Throttle Trigger Lockout.
16. **THROTTLE TRIGGER LOCKOUT** - Operation of the throttle trigger is prevented unless throttle trigger lockout lever is engaged.
17. **THROTTLE TRIGGER** - Spring loaded to return to idle when released. During acceleration press throttle trigger gradually for best operating technique..
18. **DECOMPRESSION BUTTON** - Push button to assist starting. Automatically resets after engine starts and runs.
19. **LOWER SUPPORT HANDLE** - Used for support grip by Operator during two-man operation.
20. **SPARK PLUG** - Provides spark to ignite fuel mixture.

---

## CONTENTS

---

The ECHO product you purchased has been factory pre-assembled for your convenience. Due to packaging restrictions, some assembly may be necessary.

After opening the carton, check for damage. Immediately notify your retailer or ECHO Dealer of damaged or missing parts. Use the contents list to check for missing parts.

- \_\_\_\_ - 1, Power Head/Handle/Gear Case Assembly
- \_\_\_\_ - 1, Operator's Manual
- \_\_\_\_ 1, Emission Control Warranty Statement

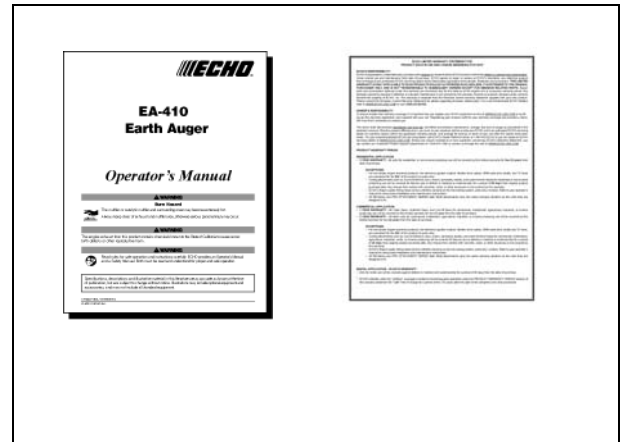

## ASSEMBLY

### Throttle Handle Assembly

Parts Required: Throttle Handle Assembly, Screw, Hex nut.

1. Cut and remove one (1) white plastic shipping tie that secures handle assembly to packing materials.

Note: DO NOT cut or remove black plastic ties.

2. Remove mounting screw and hex nut from throttle handle assembly, and slide throttle handle onto mounting bar.
3. Align hole in throttle handle assembly with hole in bar.
4. Secure throttle handle to bar with screw and hex nut.
5. Tighten securely.

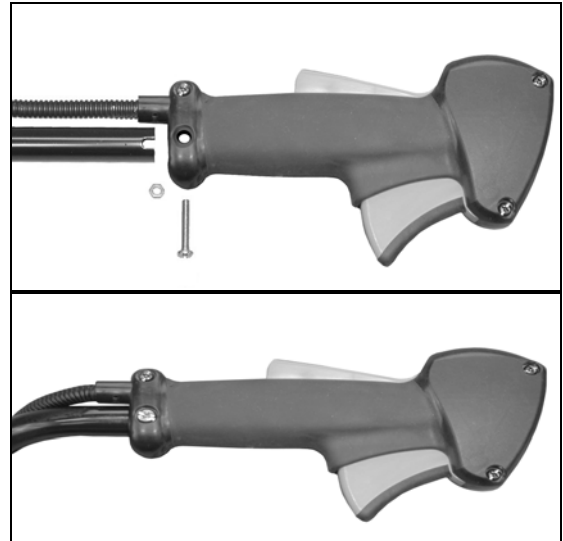

### Auger Installation

Parts Required: Auger Blade Assembly - Includes: 6 - 10 in. Earth Auger: 3/8-16 x 1- 1/2" Bolt, 3/8-16 Hex Nut, 2 - 4 in. Earth Augers: 3/8-16 x 1- 1/4" Socket Head Screw, 8 - 10 in. Ice Augers: 3/8-16 x 1- 1/4" Socket Head Screw

1. Carefully place engine on a flat surface with muffler side down.
2. Remove assembly hardware from auger.
3. Slide auger assembly onto gear case PTO shaft.
4. Align PTO shaft mounting hole with auger mounting hole.
5. Secure auger to PTO shaft with hardware provided, and tighten securely.

Note: Six, 8, & 10 in. Earth Augers hardware style shown in illustration. Two, 3, & 4 in. Earth augers and 8 & 10 in. Ice Augers use socket head screws only.

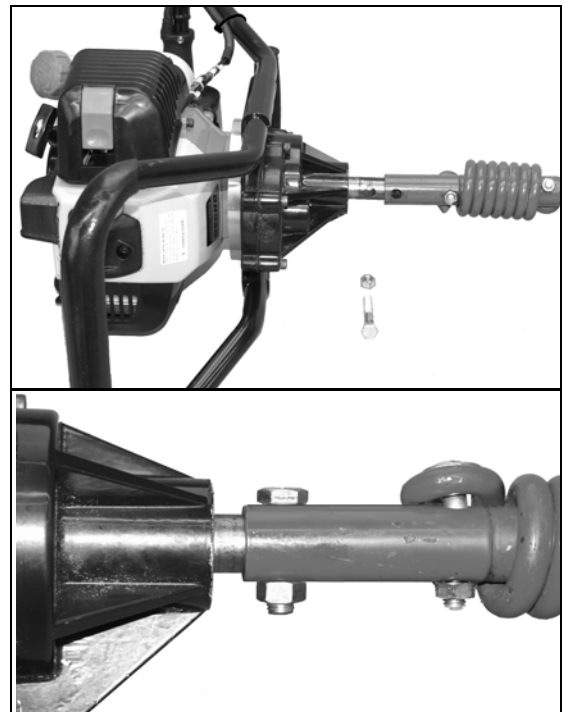

## Auger Extension

Parts Required: Auger Extension, 12 or 18 in. Includes assembly hardware.

### **⚠ WARNING**

***The muffler and area around the muffler may be extremely hot. Avoid contact with this area, otherwise serious injury may result.***

### **⚠ WARNING**

***Never operate auger with handles above chest height, otherwise you could lose control, resulting in serious personal injury.***

1. Drill hole into ground 15 to 20 in. deep. Stop engine, and clean off auger mounting bolt hardware.
2. Remove auger mounting hardware. Lift engine off auger, and set aside. The engine should be supported on the ground by the handles and PTO shaft.
3. Remove extension hardware.
4. Slide extension onto auger shaft, align holes, and install mounting hardware. Tighten securely.
5. Install engine on extension shaft, and secure with hardware removed in step 2. Tighten securely.



---

**OPERATION**

---

**⚠ WARNING**

***Moving parts can amputate fingers or cause severe injuries. Keep hands, clothing and loose objects away from all openings. Always stop engine, disconnect spark plug, and make sure all moving parts have come to a complete stop before removing obstructions, clearing debris, or servicing unit.***

**⚠ WARNING**

***Operation of this equipment may create sparks that can start fires. This unit is equipped with a spark arrestor to prevent discharge of hot particles from the engine. Metal cutters can create sparks if the cutter strikes rocks, metal, or other hard objects. Contact local fire authorities for laws or regulations regarding fire prevention requirements.***

**Fuel****⚠ WARNING**

***Alternative fuels, such as E-15 (15% ethanol), E-85 (85% ethanol) or any fuels not meeting ECHO requirements are NOT approved for use in ECHO 2-stroke gasoline engines. Use of alternative fuels may cause performance problems, loss of power, overheating, fuel vapor lock, and unintended machine operation, including, but not limited to, improper clutch engagement. Alternative fuels may also cause premature deterioration of fuel lines, gaskets, carburetors and other engine components.***

**Fuel Requirements**

**Gasoline** - Use 89 Octane [R+M/2] (mid grade or higher) gasoline known to be good quality. Gasoline may contain up to 10% Ethanol (grain alcohol) or 15% MTBE (methyl tertiary-butyl ether). Gasoline containing methanol (wood alcohol) is **NOT** approved. ECHO brand Power Fuel™ is 93 octane, ethanol-free fuel premixed with ECHO Red Armor® engine oil at 50:1 ratio. Use of ECHO Power Fuel™ is recommended to extend engine life in all air-cooled 2-stroke and 2/4-stroke hybrid engines.

**Two Stroke Oil** - A two-stroke engine oil meeting ISO-L-EGD (ISO/CD 13738) and J.A.S.O. FD Standards must be used. Echo brand premium Power Blend X™ Universal 2-Stroke Oil meets these standards. Engine problems due to inadequate lubrication caused by failure to use an ISO-L-EGD (ISO/CD 13738) and J.A.S.O. FD certified oil, such as Echo premium Power Blend X™, will void the two-stroke engine warranty.

**NOTICE**

*Echo premium Power Blend X™ Universal 2-Stroke Oil may be mixed at 50:1 ratio for application in all Echo engines sold in the past regardless of ratio specified in those manuals.*

**Handling Fuel****⚠ DANGER**

***Fuel is VERY flammable. Use extreme care when mixing, storing or handling, or serious personal injury may result.***

- ***Use an approved fuel container.***
- ***DO NOT smoke near fuel.***
- ***DO NOT allow flames or sparks near fuel.***



- **Fuel tanks/cans may be under pressure. Always loosen fuel caps slowly allowing pressure to equalize.**
- **NEVER refuel a unit when the engine is HOT or RUNNING!**
- **DO NOT fill fuel tanks indoors. ALWAYS fill fuel tanks outdoors over bare ground.**
- **DO NOT overfill fuel tank. Wipe up spills immediately.**
- **Securely tighten fuel tank cap and close fuel container after refueling.**
- **Inspect for fuel leakage. If fuel leakage is found, do not start or operate unit until leakage is repaired.**
- **Move at least 3 m (10 ft.) from refueling location before starting the engine.**

### Mixing Instructions

1. Fill an approved fuel container with half of the required amount of gasoline.
2. Add the proper amount of 2-stroke oil to gasoline.
3. Close container and shake to mix oil with gasoline.
4. Add remaining gasoline, close fuel container, and remix.

Fuel to Oil Mix - 50:1 Ratio			
US		Metric	
Gas	Oil	Gas	Oil
Gallons	Oz.	Liter	CC.
1	2.6	5	100
2	5.2	10	200
5	13	25	500

## NOTICE

*Spilled fuel is a leading cause of hydrocarbon emissions. Some states may require the use of automatic fuel shut-off containers to reduce fuel spillage.*

### After use

- DO NOT store a unit with fuel in its tank. Leaks can occur. Return unused fuel to an approved fuel storage container.

**Storage** - Fuel storage laws vary by locality. Contact your local government for the laws affecting your area. As a precaution, store fuel in an approved, airtight container. Store in a well-ventilated, unoccupied building, away from sparks and flames.



For more information scan this QR code.

## NOTICE

*Stored fuel ages. Do not mix more fuel than you expect to use in thirty (30) days, ninety (90) days when a fuel stabilizer is added.*

## NOTICE

*Stored two-stroke fuel may separate. ALWAYS shake fuel container thoroughly before each use.*

## Starting Cold Engine

1. Place auger on flat surface, recoil starter handle (A) up.

2. *Stop Switch*

Move stop switch button (B) forward, away from the "STOP" position.

3. *Choke Lever*

Move choke lever (C) to Cold Start Position (I←|).

4. *Decompression Button*

Press decompression button (D) once.

5. *Purge Bulb*

Pump purge bulb (E) until fuel is visible and flows freely in the clear fuel tank return line. Pump bulb an additional 4 or 5 times.

6. *Recoil Starter*

Hold support handle securely with one hand, and pull the recoil starter handle (A) until engine fires (5 or 6 pulls). Do not hold engine by the throttle handle. DO NOT depress throttle trigger when starting.

7. *Choke Lever*

Move the choke lever to the OPEN - RUN position (|↓|) position. Restart engine if necessary and allow to warm up at idle for several minutes.

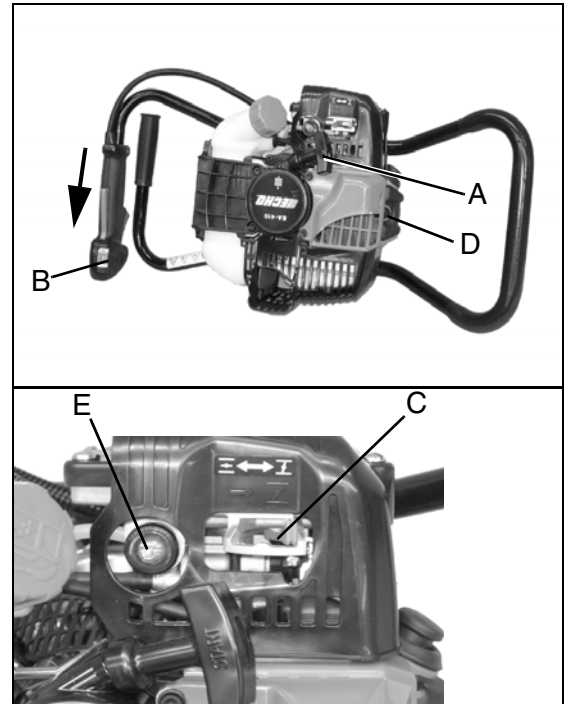

Note: After engine starts, engine decompression button will automatically reset for normal operation.

### ⚠ WARNING

**The auger attachment should not rotate at idle. If attachment rotates, readjust carburetor according to "Carburetor Adjustment" instructions in this manual or see your ECHO Dealer, otherwise serious personal injury may result.**

## Starting Warm Engine

The starting procedure is the same as Cold Start except DO NOT close the choke.

### ⚠ WARNING

**When engine starts, the auger attachment may rotate, even with the throttle trigger in idle (released) position.**

1. *Stop Switch*

Move stop switch button (B) forward away from the "STOP" position.

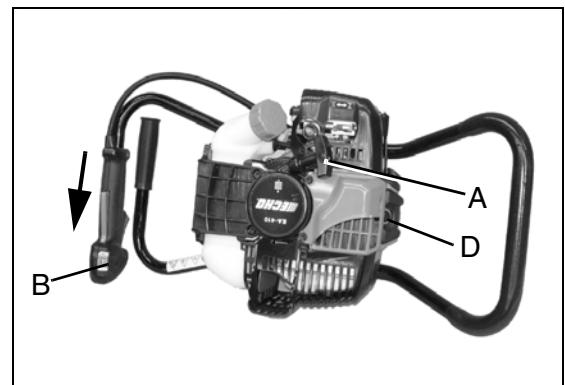

2. *Purge Bulb*  
Pump purge bulb (E) until fuel is visible in the “Clear” fuel return line.
3. *Decompression Button*  
Press decompression button (D) once.
4. *Recoil Starter*  
Lay the unit on a flat, clear area, and pull the recoil starter handle (A) until the engine fires.

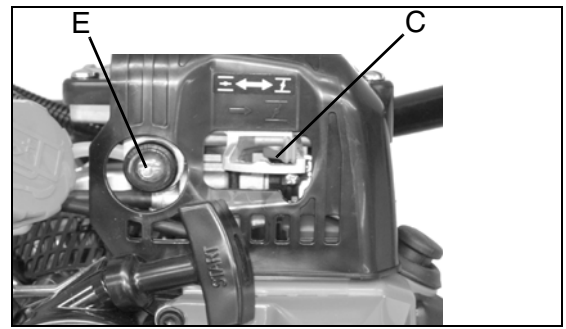

Note: If engine does not start after 5 pulls, use Cold Start Procedure.

## Stopping Engine

1. *Throttle*  
Allow engine to return to idle before shutting off engine.
2. *Stop Switch*  
Move stop switch button (B) backward to “STOP” position.

### **⚠ WARNING**

***If engine does not stop when stop switch is moved to STOP position, close choke - COLD START position - to stall engine. Have your ECHO dealer repair stop switch before using unit again.***

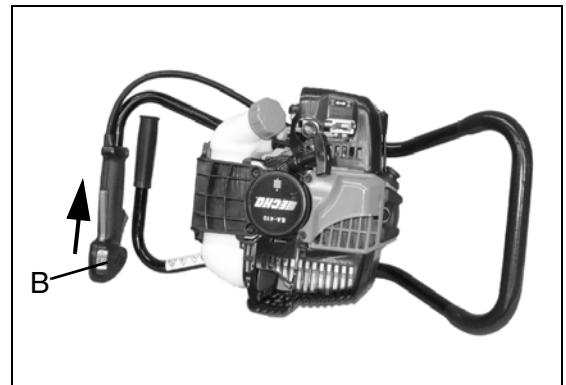

## Drilling

### ⚠ WARNING

**Engine exhaust IS HOT, and contains Carbon Monoxide (CO), a poison gas. Breathing CO can cause unconsciousness, serious injury, or death. Exhaust can cause serious burns. ALWAYS position unit so that exhaust is directed away from your face and body.**

1. After starting engine, position auger upright at desired drilling point.
2. Position feet for a stable stance, away from auger blades.
3. Firmly grip Throttle Handle and support handle.
4. Slowly squeeze throttle trigger to engage clutch and rotate auger. Apply light downward pressure on handles to drill hole. Periodically, raise the auger to help clear drilling debris from the hole.
5. Overloading the auger during drilling may cause it to stop turning. When this occurs, lift the auger to reduce the drilling load on the engine, and allow drilling debris to be augered out of the hole. Resume drilling.



### NOTICE

While drilling, the auger may twist suddenly and forcefully if it contacts large rocks, roots, or other hidden obstacles. Release throttle trigger immediately, and lift auger out of hole. Clear the obstacles to prevent damage, and then resume drilling.

6. Drilling holes six inches in diameter or larger may be easier if two people hold the handles on opposite sides.
7. Two-man Operation - The operator (A), guides the auger while gripping the Throttle Handle Assembly and lower hand grip. The helper (B), assists by guiding auger while gripping loop handle on opposite side of auger.
8. Do not place excessive body weight on the unit. Allow auger to drill with a shaving action using light downward pressure.
9. Do not use an ice auger in earth, or an earth auger in ice. A different style of auger is required for each type of drilling.
10. Do not operate unit in excessively rocky ground.

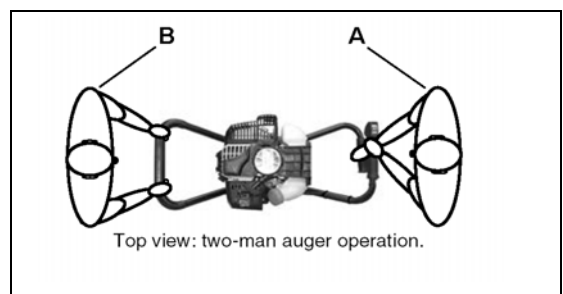

### ⚠ WARNING

**Never operate auger with handles above chest height, otherwise you could lose control, resulting in serious personal injury.**

### ⚠ WARNING

**During operation, the muffler or catalytic muffler and surrounding cover become hot. Always keep exhaust area clear of flammable debris during use, otherwise serious property damage or personal injury may result.**

## MAINTENANCE

### WARNING

**Moving parts can amputate fingers or cause severe injuries. Keep hands, clothing and loose objects away from all openings. Always stop engine, disconnect spark plug, and make sure all moving parts have come to a complete stop before removing obstructions, clearing debris, or servicing unit. Allow unit to cool before performing service. Wear gloves to protect hands from sharp edges and hot surfaces.**

Your ECHO unit is designed to provide many hours of trouble free service. Regular scheduled maintenance will help your unit achieve that goal. If you are unsure or are not equipped with the necessary tools, you may want to take your unit to an ECHO Service Dealer for maintenance. To help you decide whether you want to DO-IT-YOURSELF or have the ECHO Dealer do it, each maintenance task has been graded. If the task is not listed, see your ECHO Dealer for repairs.

### Skill Levels

**Level 1** = Easy to do. Common tools may be required.

**Level 2** = Moderate difficulty. Some specialized tools may be required.

ECHO offers **REPOWER™** Maintenance Kits and Parts to make your maintenance job easier.

### Maintenance Intervals

COMPONENT/SYSTEM	MAINTENANCE PROCEDURE	REQ'D SKILL LEVEL	DAILY OR BEFORE USE	EVERY REFUEL	3 MONTHS	YEARLY
Air Filter	Inspect/Clean	1	I / C *		R *	
Choke Shutter	Inspect/Clean	1	I / C			
Fuel Filter	Inspect/Replace	1			I *	I / R *
Fuel Cap Gasket	Inspect/Replace	1			I *	R *
Fuel System	Inspect/Replace	1	I (1) *	I (1) *		
Spark Plug	Inspect/Clean	1			I / C / R *	
Cooling System	Inspect/Clean	2	I / C			
Muffler Spark Arrestor	Inspect/Clean/Replace	2			I / C / R *	
Cylinder Exhaust Port	Inspect/Clean/Decarbon	2			I / C	
Gear Housing	Inspect	1			I **	
Recoil Starter Rope	Inspect/Clean	1	I / C *			
Screws/Nuts/Bolts	Inspect/Tighten/Replace	1	I *			

**MAINTENANCE PROCEDURE LETTER CODES: I = INSPECT, R = REPLACE, C = CLEAN**

**IMPORTANT NOTE** - Time intervals shown are maximum. Actual use and your experience will determine the frequency of required maintenance.

#### **MAINTENANCE PROCEDURE NOTES:**

(1) Low evaporative fuel tanks DO NOT require regular maintenance to maintain emission integrity.

\* Replacement is recommended based on the finding of damage or wear during inspection.

\*\*Requires no user maintenance.

## Air Filter

### Level 1.

Parts Required: REPOWER™ Tune-Up Kit.

1. Brush dirt off air cleaner area. Keep dirt away from engine and air intake grid.
2. Remove air filter cover. Brush dirt from inside cover and away from edges of air filter.
3. Check air filter seal for tight fit with air filter case.
4. Remove air filter from case. Use care to prevent dirt and debris from falling into air filter case.
5. Inspect filter element and seal. Replace filter if any of these problems are present:
  - Air filter seal does not fit tightly against case.
  - Air filter seal is distorted, worn, or damaged.
  - Air filter element has holes or other damage.
  - Air filter element is saturated with dirt.
  - Air filter element is soaked with fuel mix.
6. If air filter is in good condition and can be cleaned and reused, lightly brush debris from air filter element, or blow filter element clean using low pressure (40 psi or less) compressed air directed at inside of filter.



### NOTICE

*When using compressed air, always direct air stream at inside surface of filter so dust and debris will be blown out of filter. Keep air nozzle 6 - 8 inches away from filter to prevent damage to filter.*

7. Install air filter in case, and replace cover.

### NOTICE

*Actual replacement interval for air filter depends on operating conditions. Operation in dustier applications requires more frequent cleaning and replacement. Continued operation with a damaged or excessively dirty filter will allow dirt and debris to enter engine, and result in poor performance, rapid engine wear, and premature engine failure.*

## Fuel Filter

### Level 1.

Parts Required: REPOWER™ Tune-Up Kit.

### **⚠ DANGER**

***Fuel is VERY flammable. Use extreme care when mixing, storing or handling, or serious personal injury may result.***

1. Use a clean rag to remove loose dirt from around fuel cap and empty fuel tank.
2. Use a hook to pull the fuel line and filter from the tank.



- Remove the filter from the line and install the new filter.

Note: Federal EPA regulations require all model year 2012 and later gasoline powered engines produced for sale in the United States to be equipped with a special low permeation fuel supply hose between the carburetor and fuel tank. When servicing model year 2012 and later equipment, only fuel supply hoses certified by EPA can be used to replace the original equipment supply hose. Fines up to \$37,500 may be enforced for using an un-certified replacement part.

## Spark Plug

### Level 2.

Parts Required: REPOWER™ Tune-Up Kit

### NOTICE

*Use only NGK BPM-7A spark plug (BPMP-7A in Canada) otherwise severe engine damage may occur.*

- Remove spark plug and check for fouling, worn and rounded center electrode.
- Clean the plug or replace with a new one. DO NOT sand blast to clean. Remaining sand will damage engine.
- Adjust spark plug gap by bending outer electrode.
- Tighten spark plug to 150-170 kgf • cm (130-150 in • lbf).

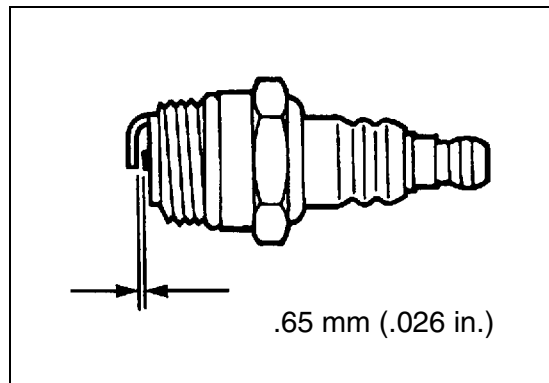

## Cooling System

### Level 2.

Parts Required: None if you are careful.

### NOTICE

*To maintain proper engine operating temperatures, cooling air must pass freely through the cylinder fin area. This flow of air carries combustion heat away from the engine.*

Overheating and engine seizure can occur when:

- Air intakes are blocked, preventing cooling air from reaching the cylinder.
- Dust and grass build up on the outside of the cylinder. This build up insulates the engine and prevents the heat from leaving.

Removal of cooling passage blockages or cleaning of cooling fins is considered "Normal Maintenance." Any failure attributed to lack of maintenance is not warranted.

- Periodically blow dirt and debris off cooling fins with a compressor and safety nozzle, or;



- Remove engine and muffler covers, and brush off dirt and debris using the medium bristle brush

## Exhaust System

### Spark Arrestor Screen

#### Level 2.

Parts Required: Spark Arrestor Screen, Gasket

- Remove muffler cover (A).
  - Place piston at Top Dead Center (TDC) to prevent carbon/dirt from entering cylinder.
  - Remove spark arrestor screen cover (B), screen holder (C), gaskets (D), and screen (E), from muffler body.
  - Clean carbon deposits from muffler components.
- Note: When cleaning carbon deposits, be careful not to damage the catalytic element inside muffler.
- Replace screen if it is cracked, plugged, or has holes burned through.
  - Assemble components in reverse order.

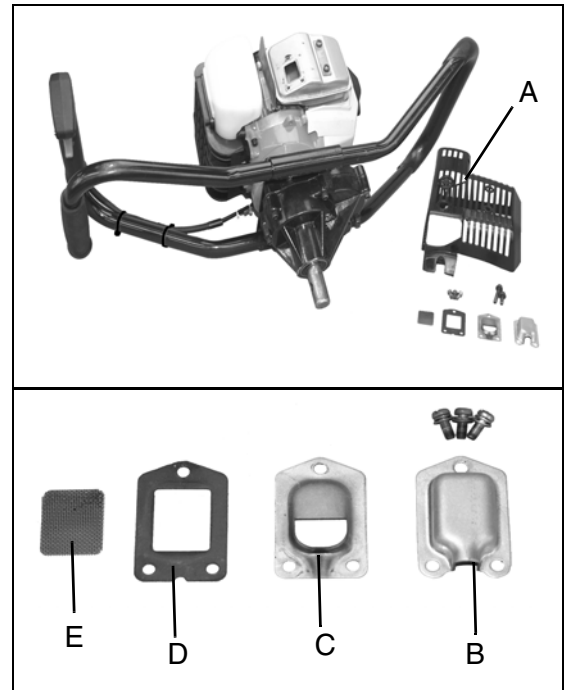

### Exhaust Port Cleaning

#### Level 2.

Parts Required: As needed: Heat Shield

- Remove spark plug lead from spark plug, and remove engine cover.
- Place piston at top dead center. Remove muffler (A) and heat shield (B).
- Use a wood or plastic scraping tool to clean deposits from cylinder exhaust port.

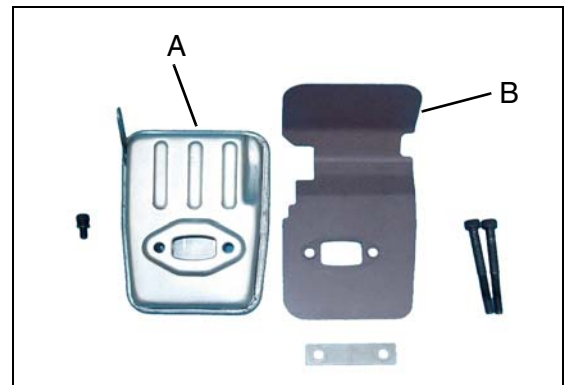

### NOTICE

*Never use a metal tool to scrape carbon from the exhaust port. Do not scratch the cylinder or piston when cleaning the exhaust port. Do not allow carbon particles to enter the cylinder.*



4. Inspect heat shield, and replace if damaged.
5. Install heat shield and muffler.
6. Tighten muffler mounting bolts (or nuts) to 95-130 in•lb (110-150 kgf•cm).
7. Attach spark plug lead and install engine cover.
8. Start engine, and warm to operating temperature.
9. Stop engine, and re-tighten mounting bolts (or nuts) to specifications.

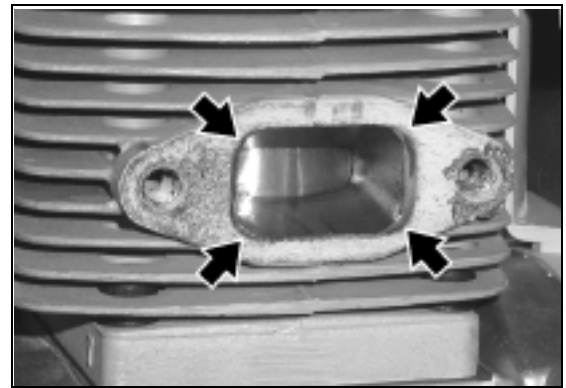

## Gear Housing

### Level 1.

1. Inspect gear housing for cracks in surface; leaks at joints, bearings, or seals; or damage of any kind.

### NOTICE

*If any damage is found, return unit to an authorized Echo dealer for repair.*



## Carburetor Adjustment

### Level 2.

### Engine Break-In

New engines must be operated a minimum duration of two tanks of fuel break-in before carburetor adjustments can be made. During the break-in period your engine performance will increase and exhaust emissions will stabilize. Idle speed can be adjusted as required.

### High Altitude Operation

This engine has been factory adjusted to maintain satisfactory starting, emission, and durability performance up to 1,100 feet above sea level (ASL) (96.0 kPa). To maintain proper engine operation and emission compliance above 1,100 feet ASL the carburetor may need to be adjusted by an authorized ECHO service dealer.

### NOTICE

*If the engine is adjusted for operation above 1,100 feet ASL, the carburetor must be re-adjusted when operating the engine below 1,100 feet ASL, otherwise severe engine damage may result.*

Parts                None  
Required:

Note: Every unit is run at the factory and the carburetor is set in compliance with emission regulations. Carburetor adjustments, other than idle speed, must be performed by an authorized ECHO dealer.

1. Check idle speed and reset if necessary. If a tachometer is available, idle speed screw (A) should be set to the specifications found on “Specifications” page of this manual. Turn idle screw (A) clockwise to increase idle speed; counter clockwise to decrease idle speed.

**⚠ WARNING**

***When carburetor adjustment is completed, the cutting attachment should not move at idle, otherwise serious personal injury may result.***

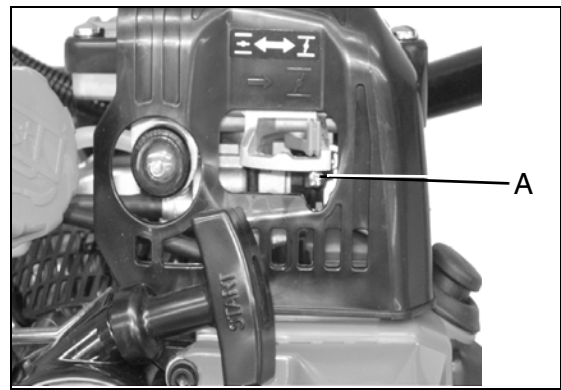

## TROUBLESHOOTING

ENGINE PROBLEM TROUBLESHOOTING CHART				
Problem	Check	Status	Cause	Remedy
Engine cranks - starts hard/ doesn't start	Fuel at carburetor	No fuel at carburetor	Fuel strainer clogged Fuel line clogged Carburetor	Clean or replace Clean or replace See your Echo dealer
	Fuel at cylinder	No fuel at cylinder	Carburetor	See your Echo dealer
		Muffler wet with fuel	Fuel Mixture too rich	OPEN choke Clean/replace air filter Adjust carburetor See your Echo dealer
	Spark at end of plug wire	No spark	Stop switch OFF Electrical problem Interlock switch	Turn switch to ON See your Echo dealer See your Echo dealer
Spark at plug	No spark	Spark gap incorrect Covered with carbon Fouled with fuel Plug defective	Adjust to 0.65mm (0.026 in.) Clean or replace Clean or replace Replace plug	
Engine runs, but dies or does not accelerate properly	Air filter	Air filter dirty	Normal wear	Clean or replace
	Fuel filter	Fuel filter dirty	Contaminants/residues in fuel	Replace
	Fuel vent	Fuel vent plugged	Contaminants/residues in fuel	Clean or replace
	Spark Plug	Plug dirty/worn	Normal wear	Clean and adjust or replace
	Carburetor	Improper adjustment	Vibration	Adjust
	Cooling System	Cooling system dirty/plugged	Extended operation in dirty/dusty locations	Clean
Spark Arrestor Screen	Spark arrestor screen plugged	Normal wear	Replace	
Engine does not crank	N/A	N/A	Internal engine problem	See your Echo dealer

### DANGER

**Fuel vapors are extremely flammable and may cause fire and/or explosion. Never test for ignition spark by grounding spark plug near cylinder plug hole, otherwise serious personal injury may result.**

---

## STORAGE

---

### WARNING

*During operation the muffler or catalytic muffler and surrounding cover become hot. Always keep exhaust area clear of flammable debris during transportation or when storing, otherwise serious property damage or personal injury may result.*

### Long Term Storage (Over 30 Days)

Do not store your unit for a prolonged period of time (30 days or longer) without performing protective storage maintenance which includes the following:

1. Store unit in a dry, dust free place, out of the reach of children.

### DANGER

***Do not store in enclosure where fuel fumes may accumulate or reach an open flame or spark.***

2. Place the stop switch in the "OFF" position.
3. Remove accumulation of grease, oil, dirt and debris from exterior of unit.
4. Perform all periodic lubrication and services that are required.
5. Tighten all the screws and nuts.
6. Drain fuel tank completely. Press purge bulb 6-7 times to remove remaining fuel from carburetor then drain the tank again. Close choke, start and run the engine until it stops due to lack of fuel.
7.
  - a. Allow engine to cool then remove the spark plug and pour 7 cc (1/4 oz.) of fresh, clean, two-stroke engine oil into the cylinder through the spark plug hole.
  - b. Pull the recoil starter handle 2-3 times to distribute the oil inside the engine.
  - c. Observe the piston location through the spark plug hole. Pull the recoil handle slowly until the piston reaches the top of its travel and leave it there.
8. Install the spark plug (do not connect ignition cable).

## SPECIFICATIONS

MODEL	EA-410
Length	585 mm (23.0 in.)
Width	270 mm (10.6 in.)
Height	370 mm (14.6 in.)
Weight	9.8 kg (21.6 lb.)
Engine Type	Air cooled, two-stroke, single cylinder gasoline engine
Bore	40.0 mm (1.58 in.)
Stroke	34.0 mm (1.34 in.)
Displacement	42.7 cc (2.61 cu. in.)
Exhaust	Spark arrestor muffler or spark arrestor muffler with catalyst
Carburetor	Diaphragm w/purge pump
Ignition System	Flywheel magneto, capacitor discharge ignition type
Spark Plug	NGK BPM-7A (Gap 0.65 mm (0.026 in.))
Fuel	Mixed (Gasoline and Two-stroke Oil)
Fuel/Oil Ratio	50 : 1 Power Blend X™ ISO-L-EGD (ISO/CD 13738) and J.A.S.O. M345- <u>FD</u> , two-stroke, air-cooled engine oil.
Gasoline	Use 89 Octane unleaded. Do not use fuel containing methyl alcohol, more than 10% ethyl alcohol or 15% MTBE. Do not use alternative fuels such as E-15 or E-85.
Oil	Power Blend X™ Premium Universal 2-Stroke Oil
Fuel Tank Capacity	1.0 lit. (33.8 US fl. oz.)
Starter System	Automatic Rewind Starter
Clutch	Centrifugal Type
Vibration Isolated System	Cushioned left and right hand grips
PTO Shaft	22 mm (.875 in.) Diameter
Gear Case Ratio	30.2:1 Reduction
Auger Capacity	51 mm - 254 mm (2 in. - 10 in.)
Rotation	Clockwise, viewed from top
Handle	Cushioned Bow w/Grip
Idle Speed	2,500 RPM
Clutch Engagement Speed	3,600 RPM
Wide Open Throttle Speed (W.O.T.)	10,600 RPM

## AUGER ACCESSOIRES

<b><i>Earth Auger *</i></b>	<b>Part Number</b>	<b>Description</b>
	99944900150	2" Earth Auger w/point
	99944900160	3" Earth Auger w/point
	99944900170	4" Earth Auger w/point
	99944900180	6" Earth Auger w/point & spring
	99944900190	8" Earth Auger w/point & spring
	99944900200	10" Earth Auger w/point & spring
<b><i>Extension Shaft *</i></b>	99944900210	18" Extension Shaft - 7/8" diameter
	99944900220	12" Extension Shaft - 7/8" diameter
<b><i>Earth Auger Replacement Blades *</i></b>	99944900230	4" Replacement Blade - Earth Auger
	99944900240	6" Replacement Blade - Earth Auger
	99944900250	8" Replacement Blade - Earth Auger
	99944900260	10" Replacement Blade - Earth Auger
	99944900270	2" Replacement Point- Earth Auger
	99944900370	1" Replacement Point- Earth Auger
<b><i>Ice Augers *</i></b>	99944900275	Replacement Point- Ice Auger
	99944900280	8" Ice Auger - Dual Blade
	99944900290	10" Ice Auger - Dual Blade
<b><i>Ice Auger Replace Blades *</i></b>	99944900300	8" Replacement Blade - Ice Auger
	99944900310	10" Replacement Blade - Ice Auger
<b><i>Auger Adapter</i></b>	99944900335	Auger Adapter for 1 " Auger mount
* All auger accessories include required assembly hardware.		

# WARRANTY STATEMENTS

## ECHO LIMITED WARRANTY STATEMENT FOR PRODUCT SOLD IN USA AND CANADA BEGINNING 01/01/2010

### ECHO'S RESPONSIBILITY

ECHO Incorporated's Limited Warranty, provides to the original purchaser that this ECHO product is free from defects in material and workmanship. Under normal use and maintenance from date of purchase, ECHO agrees to repair or replace at ECHO's discretion, any defective product free of charge at any authorized ECHO servicing dealer within listed below application time periods, limitations and exclusions. **THIS LIMITED WARRANTY IS ONLY APPLICABLE TO ECHO PRODUCTS SOLD BY AUTHORIZED ECHO DEALERS. IT IS EXTENDED TO THE ORIGINAL PURCHASER ONLY, AND IS NOT TRANSFERABLE TO SUBSEQUENT OWNERS EXCEPT FOR EMISSION RELATED PARTS.** Repair parts and accessories replaced under this warranty are warranted only for the balance of the original unit or accessory warranty period. Any damage caused by improper installation or improper maintenance is not covered by this warranty. All parts or products replaced under warranty become the property of ECHO, Inc. This warranty is separate from the Emission control warranty statement supplied with your new product. Please consult the Emission Control Warranty Statement for details regarding emission related parts. For a list of Authorized ECHO Dealers refer to [WWW.ECHO-USA.COM](http://WWW.ECHO-USA.COM) or call **1-800-432-ECHO**.

### OWNER'S RESPONSIBILITY

To ensure trouble free warranty coverage it is important that you register your ECHO equipment on-line at [WWW.ECHO-USA.COM](http://WWW.ECHO-USA.COM) or by filling out the warranty registration card supplied with your unit. Registering your product confirms your warranty coverage and provides a direct link if we find it necessary to contact you.

The owner shall demonstrate reasonable care and use, and follow preventative maintenance, storage, fuel and oil usage as prescribed in the operator's manual. Should a product difficulty occur, you must, at your expense, deliver or ship your ECHO unit to an authorized ECHO servicing dealer for warranty repairs (within the applicable warranty period), and arrange for pick-up or return of your unit after the repairs have been made. For your nearest authorized ECHO servicing dealer, call ECHO's Dealer Referral Center, at 1-800-432-ECHO or you can locate an ECHO servicing dealer at [WWW.ECHO-USA.COM](http://WWW.ECHO-USA.COM). Should you require assistance or have questions concerning ECHO's Warranty Statement, you can contact our Consumer Product Support Department at 1-800-673-1558 or contact us through the web at [WWW.ECHO-USA.COM](http://WWW.ECHO-USA.COM).

### PRODUCT WARRANTY PERIOD

#### HOMEOWNER APPLICATION

- **5 YEAR WARRANTY** - All units for homeowner, or non-income producing use will be covered by this limited warranty for **five (5) years** from date of purchase.

#### EXCEPTIONS:

- For two-stroke engine powered products, the electronic ignition module, flexible drive cables, SRM solid drive shafts, and TC tines are warranted for the **life\*** of the product on parts only.
- Cutting attachments such as, but not limited to, bars, chains, sprockets, blades, and nylon trimmer heads for homeowner or non-income producing use will be covered for failures due to defects in material or workmanship for a period of **60 days** from original product purchase date. Any misuse from contact with concrete, rocks, or other structures is not covered by this warranty.
- ECHO's Rapid Loader String Head carries a lifetime warranty on the line locking system, parts only; no labor. Refer to your operator's manual for string head installation and maintenance instructions.
- All SB-Series and PRO ATTACHMENT SERIES Split Shaft attachments carry the same warranty duration as the units they are designed to fit.

#### COMMERCIAL APPLICATION

- **1 YEAR WARRANTY** - All Chain Saws, QuikVent Saws, and Cut-Off Saws for commercial, institutional, agricultural, industrial, or income producing use will be covered by this limited warranty for one **(1) year** from the date of purchase.
- **2 YEAR WARRANTY** - All other units for commercial, institutional, agricultural, industrial, or income producing use will be covered by this limited warranty for two **(2) years** from the date of purchase.

#### EXCEPTIONS:

- For two-stroke engine powered products, the electronic ignition module, flexible drive cables, SRM solid drive shafts and TC tines, are warranted for the **life\*** of the product on parts only.
- Cutting attachments such as, but not limited to, bars, chains, sprockets, blades, and nylon trimmer heads for commercial, institutional, agricultural, industrial, rental, or income producing will be covered for failures due to defects in material or workmanship for a period of **30 days** from original product purchase date. Any misuse from contact with concrete, rocks, or other structures is not covered by this warranty.
- ECHO's Rapid Loader String Head carries a lifetime warranty on the line locking system, parts only; no labor. Refer to your operator's manual for string head installation and maintenance instructions.
- All SB-Series and PRO ATTACHMENT SERIES Split Shaft attachments carry the same warranty duration as the units they are designed to fit.

#### RENTAL APPLICATION - 90 DAYS WARRANTY

- Units for rental use will be covered against defects in material and workmanship for a period of 90 days from the date of purchase.

\* ECHO's liability under the "Lifetime" coverage is limited to furnishing parts specified under the PRODUCT WARRANTY PERIOD section of this warranty statement for "**Life**" free of charge for a period of ten (10) years after the date of the complete unit's final production.

ECHO does not offer an over the counter exchange program. Any ECHO product re-built other than by ECHO or sold through an unauthorized dealer, or an unauthorized outlet store, is sold without ECHO's limited warranty coverage. The ECHO Limited Warranty coverage is extended to the original purchaser only, and is not transferable except for emission related parts. Repair parts and accessories replaced under this warranty are warranted only for the balance of the original unit or accessory warranty period. Any damage caused by improper installation or improper maintenance is not covered by this warranty. All parts or products replaced under warranty become the property of ECHO.

#### **PURCHASED REPAIR PARTS, SHORT BLOCKS AND ACCESSORIES**

- 90-day homeowner, or non-income producing warranty
- 30-day commercial, institutional, agricultural, industrial, income producing, or rental application warranty

#### **ATTENTION TWO-STROKE ENGINE POWER PRODUCT OWNERS**

This ECHO two-stroke engine power product is a quality-engineered unit which has been manufactured to exact tolerances to provide superior performance. To help ensure the performance of the unit, it is required to use two-stroke oil which meets the ISO-L-EGD Standard per ISO/CD 13738 and JASO M345FD Standards. **ECHO Power Blend™ Two-Stroke Oil** is a premium two-stroke oil specifically formulated to meet ISO-L-EGD (ISO/CD 13738) and JASO M345FD Standards. The use of two-stroke oils designed for other applications, such as for outboard motors or lawnmowers can result in severe engine damage, and will void your two-stroke engine limited warranty.

#### **THIS WARRANTY DOES NOT COVER DAMAGE CAUSED BY:**

- Lack of lubrication or engine failure, due to the use of two-stroke oils that do not meet the ISO-L-EGD (ISO/CD 13738) and JASO M345FD Standards. Engine problems due to inadequate lubrication caused by failure to use an ISO-L-EGD compliant and JASO M345FD registered oil, will void the two-stroke engine limited warranty. ECHO Power Blend™ Two-Stroke Oil meets the ISO-L-EGD and JASO M345FD Standard. Emission related parts are covered for 5 years homeowner use or 2 years commercial use regardless of two-stroke oil used, per the statement listed in the EPA or California Emission Defect Warranty Explanation.
- Damage caused by use of gasohol, containing methanol (wood alcohol), or gasoline containing less than 89 octane. Only use gasoline which contains 89 octane or higher. Gasohol which contains a **maximum** 10% ethanol (grain alcohol) or 15% MTBE (methyl/tertiary/butyl/ether) is also approved. The prescribed mixing ratio of gasoline to oil is listed on the ECHO oil label and covered in your operator's manual.
- Engine damage caused by use of ether or any starting fluids.
- Damage caused by tampering with engine speed governor or emission components, or running engines above specified and recommended engine speeds as listed in your operator's manual.
- Operation of the unit with improperly maintained/removed cutting shield or removed/damaged air filter.
- Damage caused by dirt, pressure or steam cleaning the unit, salt water, corrosion, rust, varnish, abrasives, and moisture.
- Defects, malfunctions or failures resulting from abuse, misuse, neglect, modifications, alterations, normal wear, improper servicing, or use of unauthorized attachments.
- Incorrect storage procedures, stale fuel, including failure to provide or perform required maintenance services as prescribed in the operator's manual. Preventative maintenance as outlined in the operators manual is the customer's responsibility.
- Failures due to improper set-up, pre-delivery service or repair service by anyone other than authorized ECHO servicing dealer during the warranty period.
- Certain parts and other items are not warranted, including but not limited to: lubricants, starter cords, and engine tune-ups.
- Use of spark plugs other than those meeting performance and durability requirements of the OEM spark plug listed in the Operator's Manuals.
- Overheating or carbon scoring failures due to restricted, clogged exhaust port or combustion chamber, including damage to spark arrester screen.
- Adjustments after the first (30) thirty days and beyond, such as carburetor adjustment and throttle cable adjustment.
- Damage to gears or gear cases caused by contaminated grease or oil, use of incorrect type or viscosity of lubricants, and/or failure to comply with recommended grease or oil change intervals.
- Damage caused by loading SHRED 'N' VAC® beyond recommended capacity.
- Damage caused by pump or sprayer running dry, pumping or spraying caustic or flammable materials, or lack of or broken strainers.
- Additional damage to parts or components due to continued use after operational problem or failure occurs. Should operational problem or failure occur, the product should not be used, but delivered as is to an authorized ECHO servicing dealer.

It is a dealer's and/or customer's responsibility to complete and return the warranty registration card supplied with your ECHO product or by visiting [WWW.ECHO-USA.COM](http://WWW.ECHO-USA.COM). Your receipt of purchase including date, model and serial number must be maintained and presented to an authorized ECHO servicing dealer for warranty service. Proof of purchase rests solely with the customer. Some states do not allow limitations on how long an implied warranty lasts, so the above limitations may not apply to you. Some states do not allow the exclusion or limitation of incidental or consequential damages, so you may also have other specific legal rights which vary from state to state. This limited warranty is given by ECHO Incorporated, 400 Oakwood Rd., Lake Zurich, IL 60047.

#### **DISCLAIMER OF IMPLIED WARRANTIES**

This limited warranty is in lieu of all other expressed or implied warranties, including any warranty of FITNESS FOR A PARTICULAR PURPOSE OR USE and any implied warranty of **MERCHANTABILITY** otherwise applicable to this product. ECHO and its affiliated companies shall not be liable for any special incidental or consequential damage, including lost profits. There are no warranties extended other than as provided herein. This limited warranty may be modified only by ECHO.

99922201032  
11/18/2011



# PRODUCT REGISTRATION

## Thank you for choosing ECHO Power Equipment

Please go to <http://www.echo-usa.com/Warranty/Register-Your-ECHO> to register your new product on-line. It's **FAST** and **EASY!** NOTE: your information will never be sold or misused by ECHO, Inc. Registering your purchase enables us to contact you in the unlikely event of a service update or product recall, and verifies your ownership for warranty consideration.

If you do not have access to the Internet, you can complete the form below and mail to:

**ECHO Inc., Product Registration, PO Box 1139, Lake Zurich IL 60047.**



**ECHO** PRODUCT REGISTRATION CARD : TARJETA DE REGISTRO : CARTE D'ENREGISTREMENT DU PRODUIT

**ONLINE OPTION:** Register online and save a stamp! You will be alerted of product updates and/or be sent new ECHO product information and special offers. Simply go to: [www.echo-usa.com](http://www.echo-usa.com)

**OPCION POR INTERNET:** Regístrate en la página web y ahorra una estampita. Le alertarán sobre actualizaciones del producto y ofertas especiales. Simplemente visite: [www.echo-usa.com](http://www.echo-usa.com)

**OPTION EN LIGNE:** Enregistrez en ligne et épargnez un timbre! Vous serez informé sur les nouveaux produits ECHO et les mises à jour de produit ainsi que les offres spéciales. Simplement visitez le: [www.echo-usa.com](http://www.echo-usa.com)

**Please Print :** Por Favor Enscriba Con Letra De Molde : En Lettre Carré S.V.P. **Confidential: Information provided will not be shared or sold**

Purchaser's Name : Nombre del Comprador : Nom de l'acheteur	
Address : Dirección : Adresse	
City : Ciudad : Ville	State : Estado : Province
Zip Code : Código Postal : Code Postal	
E-Mail Address : Dirección De Correo Electrónico : Courrier Electronique	
Phone Number : Número De Teléfono : Téléphone	Date of Purchase : Fecha de la Compra : Date de l'achat
Where Purchased : Nombre del Almacén donde fue Comprado : Lieu d'achat	
Model Number : Numero del Modelo : No. de modèle	Serial Number : Numero de Serie : No. de série

Registering your purchase enables us to contact you in the unlikely event of a service update or product recall and verifies your ownership for warranty consideration. We will never sell or share your information with anyone else. We will use your information as a mailing list for our products and services. L'enregistrement de votre achat nous permettra de vous contacter dans le cas improbable de modifications des instructions d'entretien ou de rappel du produit et vérifier que vous êtes le propriétaire en cas de vol ou de perte.

**Primary use of tool:**  Professional  Homeowner  Rental Equip.  
 Uso primario de la herramienta:  Profesional  Dueño de casa  Alquiler

**Usage principal:**  Professional  Residential  Location  
 Do you wish to receive periodic ECHO product information and special offers by e-mail?  Yes  No

¿Desea usted recibir información periódica y ofertas especiales por correo electrónico sobre el producto ECHO?  Yes  No

Souhaitez-vous recevoir périodiquement de l'information sur les produits ECHO et les offres spéciales par courrier électronique ?  Oui  Non

**Did you visit the ECHO website before purchasing your product?**  
 Yes  No

Visité usted la página web ECHO antes de comprar su producto?  
 Si  No

Avez-vous visité le site d'ECHO avant de procurer votre produit?  
 Oui  Non

**What factor(s) most influenced your purchase?**  
 Performance  Dealer  
 Reliability  Price  Quality  
 Friend/Family  Brand  Warranty  
 Funcionamiento  Precio  Distribuidor  
 Confiabilidad  Experiencia Anterior  Calidad  
 Amigo/Familia  Marca  Garantía

¿Qué factor(es) influyó más en su compra?  
 Performance  Marchand  
 Fiabilidad  Expérience  Qualité  
 Ami/Famille  Marque  Garantie

Quel facteur (facteurs) vous a influencé le plus?  
 Performance  Marchand  
 Fiabilité  Expérience  Qualité  
 Ami/Famille  Marque  Garantie

ECHO INC., 400 Oakwood Rd., Lake Zurich, IL 60047  
 1.800.432.ECHO WWW.ECHO-USA.COM X7572270206 02-2012

NOTES

---





**ECHO, INCORPORATED**

400 Oakwood Road

Lake Zurich, IL 60047

[www.echo-usa.com](http://www.echo-usa.com)

E52012001001/E52012999999